



***Product available  
worldwide***

*Europe,  
North America,  
South America  
and Asia.*

GENECS - 34 913 877 - Edition 01/05

**The intelligent way  
to organize your  
electrical enclosure**

**Satie**  
S Y S T E M

**OPTIMIZES YOUR PRODUCTION**

Pôle de la Cartisane  
11 rue des Indiennes - 68700 Cernay - France  
Tél. 00 33 (0) 389 398 398 - Fax 00 33 (0) 389 754 753  
e-mail : info@satie.fr www.satie.fr

**Satie**  
S Y S T E M

**OPTIMIZES YOUR PRODUCTION**

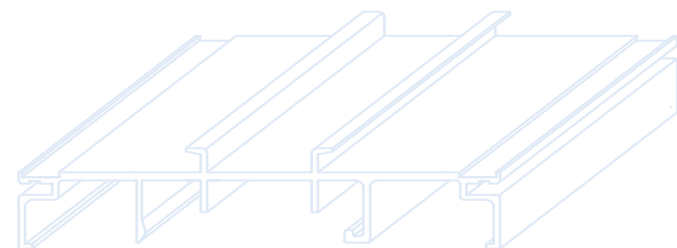

# To increase your productivity Satie designed Proclip®



The electrical panel frame that meets all your needs

*The basic idea is quite simple : assemble electrical panel frames using an innovative "snap-in" system, entirely eliminating the need for labour-intensive operations such as tracing, cutting, drilling or tapping.*

*This high-performance system was patented in 1997. It simplifies wiring, maximizes space and offers a range of concrete advantages that will generate savings at each stage of production. This innovative system:*

- ▶ saves space
- ▶ saves time
- ▶ saves energy
- ▶ and offers optimal accessibility.

*With the Proclip® range, SATIE can offer you complete turnaround service from design to the delivery of the assembled frame in record time and at very attractive prices.*

## Prolight

*We developed "Prolight" for the special requirements of installations requiring smaller enclosures.*

*The Prolight frame guarantees that your installation will be perfectly adapted to the latest technological trend of ever-increasing miniaturization of electrical components.*

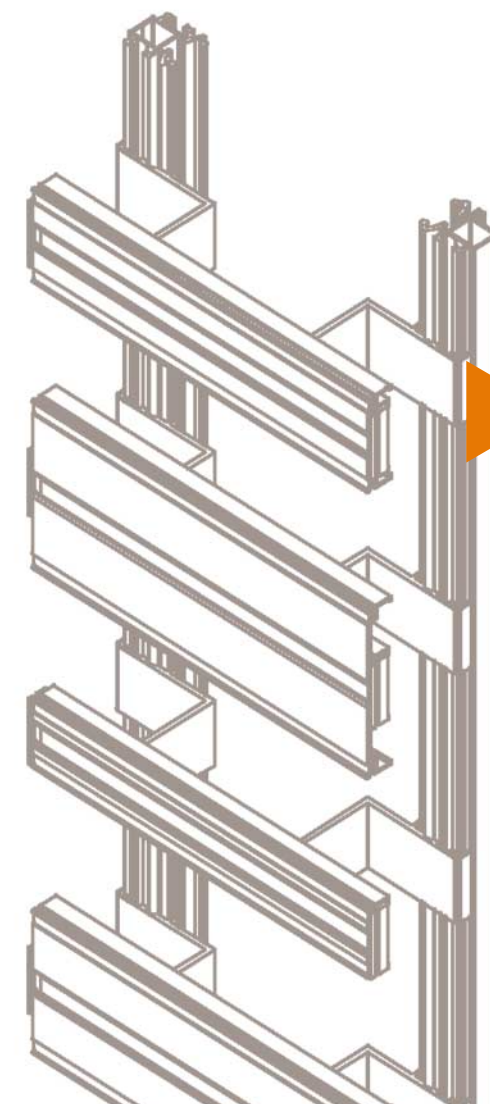

*The Proclip® system makes maximum use of the cabinet's volume to efficiently organize the wiring. With Proclip®, space savings can reach 50%.*

*Its modularity, accessibility and the reliability of the materials used make Proclip® a sensible choice.*



DIN EN 60721-3-2





# **Satie** Know-how that simplifies your life.

**A single supplier for the fabrication of your electrical panel frame**

## **Design**

### **▶ Customized solutions**

We carefully study your circuit diagram and/or your bill of material to design an optimal layout plan that will generate both space and cost savings.

## **Production**

### **▶ Speed and reliability**

Organized for customized fabrication, our production shop is equipped with highly precise cutting tools and maintains a permanent inventory of aluminium sections and plastic components. Our approach is simple : we offer you a customized product in approximately the same amount of time required for mass production.

## **Customer support**

### **▶ A new way of working together**

SATIE is always looking for ways to help you reduce costs. Due to the simplicity of the Proclip® system, we can transfer our know-how to your engineering and design department, which will soon be able to produce even more efficient panel layouts on its own.

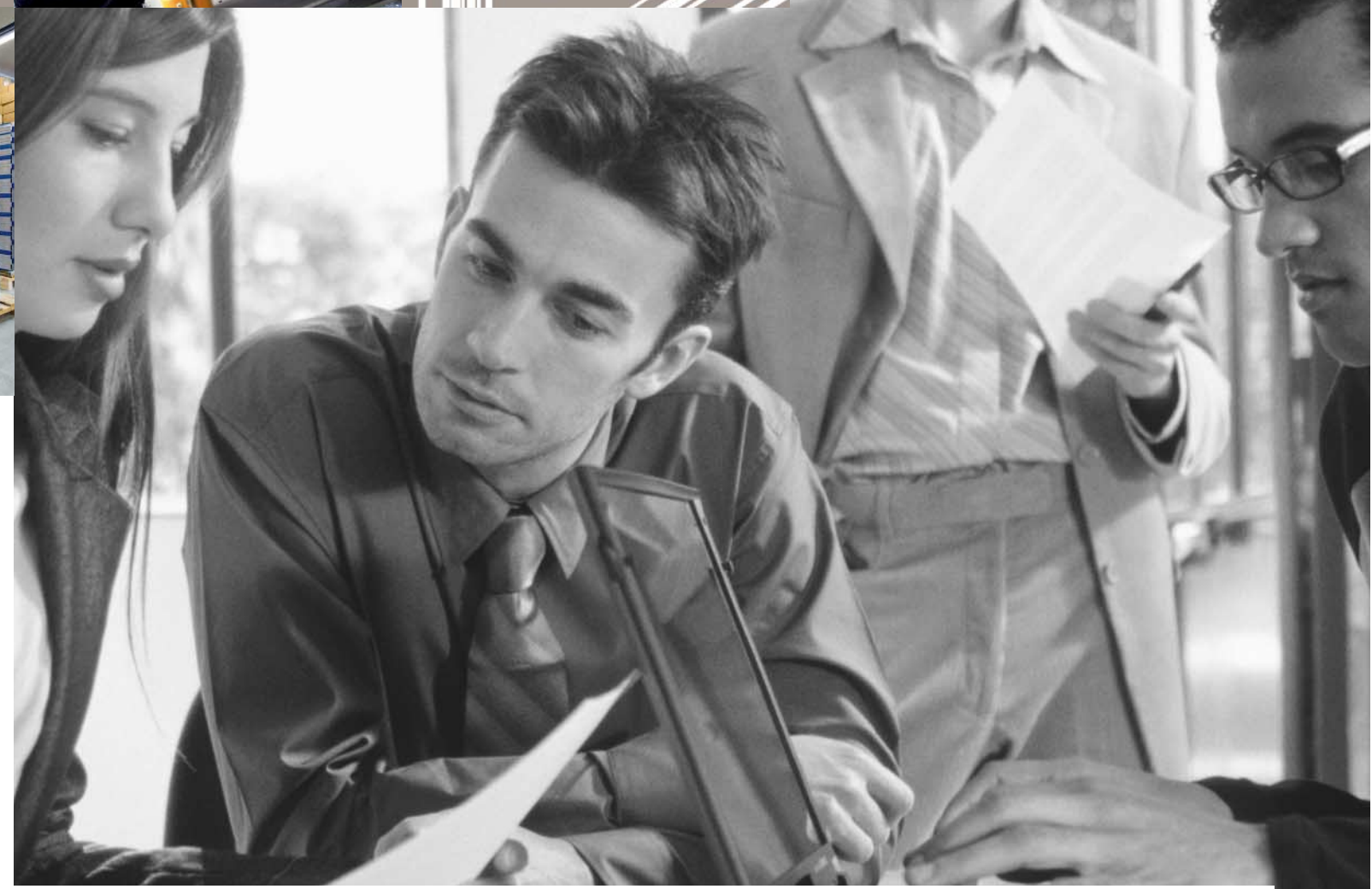





# Manufacturers and builders *with Proclip,* you save :

at every stage - from your engineering department to final operation

## Your engineering and design department

▶ **gains increased efficiency**

Your engineers can devote themselves entirely to their main task : electrical design. All we need to produce an optimal circuit diagram in the shortest possible time is a basic layout and/or a bill of material. Communication between our two departments can facilitate the solution of overcrowding problems in the same amount of space.

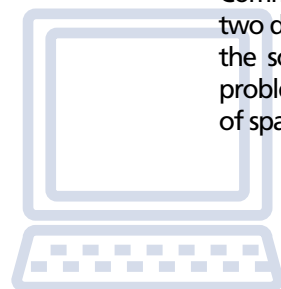

## Your purchasing department

▶ **realizes more savings**

The Proclip® system has the important advantage of simplifying your orders. A layout proposal is always accompanied by a quotation, which will reveal substantial savings in comparison with traditional layouts.



## Your electrical department

▶ **saves more time**

The Proclip® panel frame considerably reduces the time required for assembly, wiring and connection. This time savings will have a significant impact on your productivity.



▶ **and more space**

Proclip® optimizes available space. It allows you to reduce the size of your enclosure, even allowing reserve space for any future modifications.



## Your maintenance department

▶ **enjoys easier accessibility**

Wiring from the front and the snap-in system ensure that servicing the panel is quick and easy. What's more, due to the clean design and aesthetic of our system, it is much more pleasant to perform service and maintenance work on the frame.



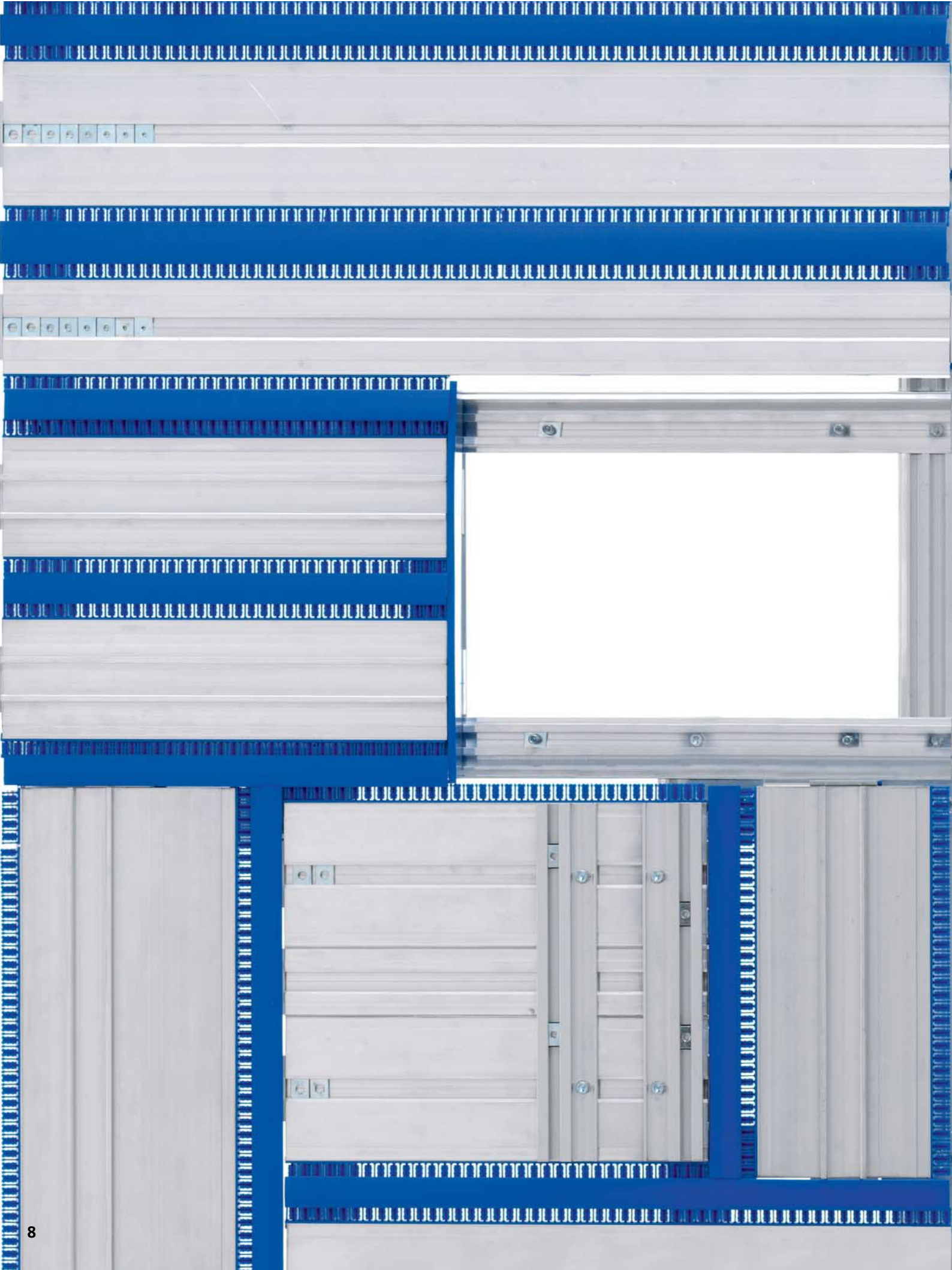

***With Proclip<sup>®</sup>  
and Prolight,  
you win on all fronts***





# 1

## Your engineering and design department gains more freedom

The combined advantages of the Proclip® system (i.e. space savings, modularity, accessibility, etc.) free your engineering and design department from constraints related to the overcrowding of certain components and make it unnecessary to calculate requirements for wire duct.

In the design stage, your department can contact our engineering department for assistance in perfecting and optimizing its design.

Over time, through the transfer of technology, your engineering and design department will become completely autonomous in the preparation of layout diagrams suited to the Proclip® technology.

## Before

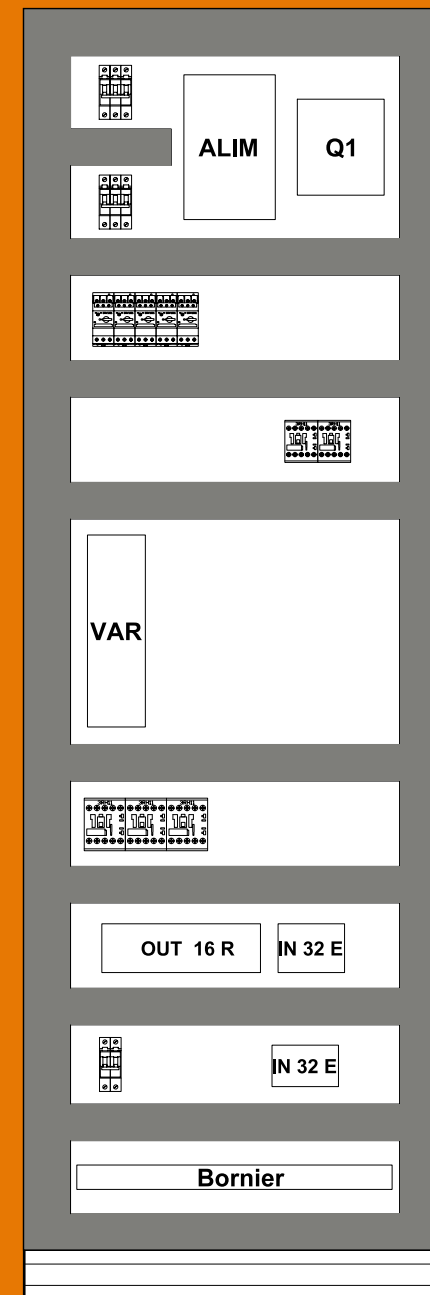

**You supply** your bill of material or layout diagram, which can be produced either using CAD software or by hand.

## After

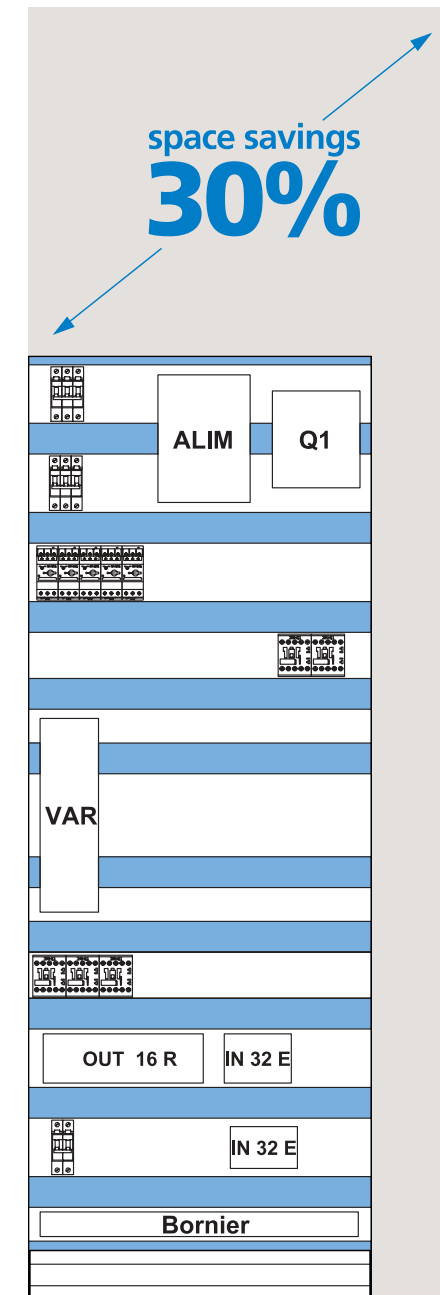

**Satie takes care of the rest!** The adaptation of your system to the Proclip® system is handled completely by SATIE.

# 2 Your purchasing department will achieve more savings

Profitability is increased at each stage of the production of a Proclip® frame. In fact, our system not only allows you to generate savings in-house by reducing the time required for design, assembly, wiring, installation and maintenance, but also by simplify your orders.

SATIE has developed a complete service system, from design to delivery of the assembled frame, which reduces the number of suppliers you need to deal with for the same project .

## A finished product ready for operation

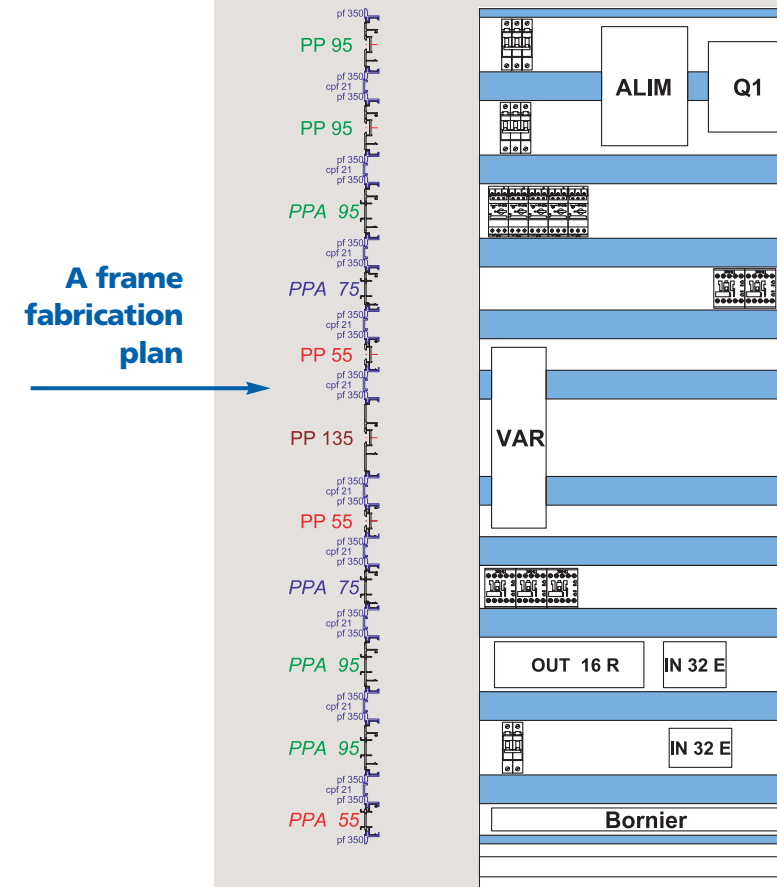

**25% less cost**

Of our proposals are produced on the basis of a layout plan that integrates all of the components required for the fabrication of the Proclip® frame. In the final analysis, the production of your Proclip® frame allows you to save up to 25% over the cost of a traditional layout including wire duct.

Added to that, consider all the other Proclip® advantages will increase your profitability even more:

- ▶ **increased productivity,**
- ▶ **less time required for wiring,**
- ▶ **optimal use of space,**
- ▶ **less handling time,**
- ▶ **savings on shipment costs.**

**3**  
**Your electrical department**  
**saves**  
**more**  
**space in**  
**the installation**

With Proclip®, you save 30% to 50% more space, while providing you with the reserve you need for future installations and retrofits.

**Your assembly**  
**time is reduced**  
**from 8 hours**  
**to 1 hours**

Assembly can be completed in less than an hour, saving you up to 7 hours in production.

**Traditional layout**



**Proclip® frame**

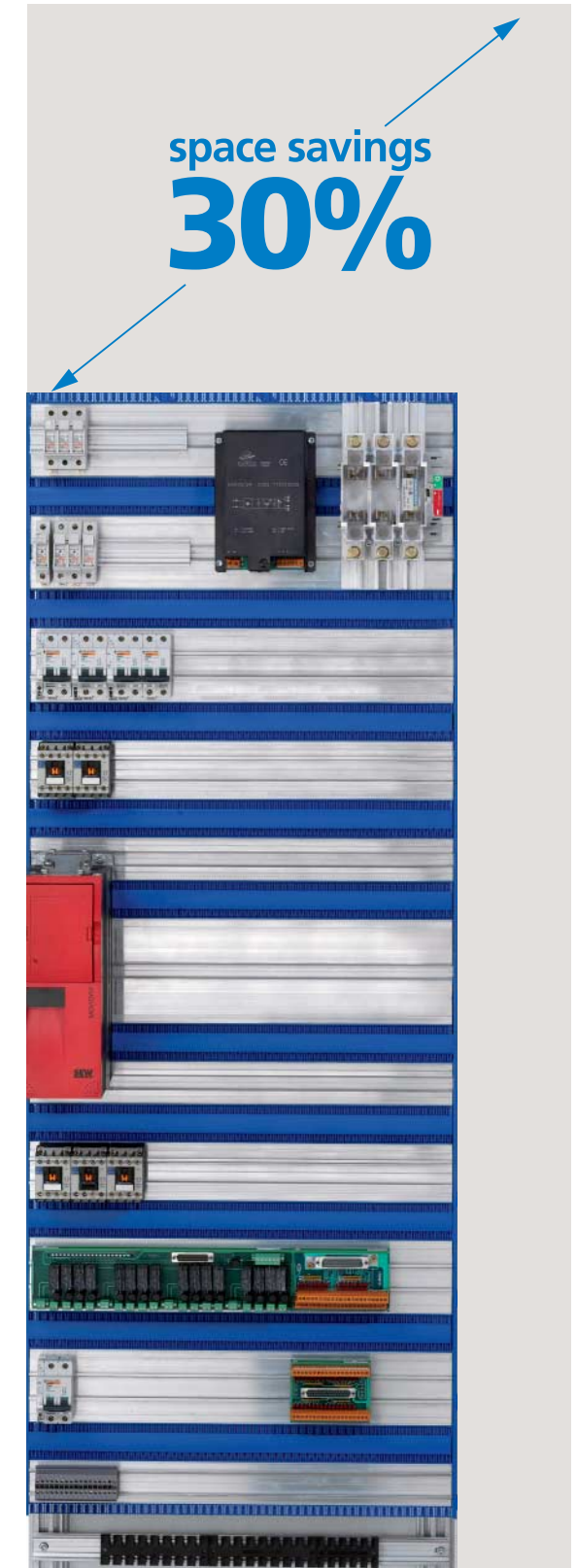



# 4 Your electrical department saves more time during wiring

Better accessibility to all connection points and easier cable routing will ensure you time savings of up to

# 30%

## Mounting the frame on the electrical enclosure



Your Proclip® frame is quick and easy to install. A wide range of accessories makes it adaptable to all enclosures, regardless of manufacturer.

## Easy wiring

With Proclip®, wiring is performed from the front, using the usual wiring techniques.

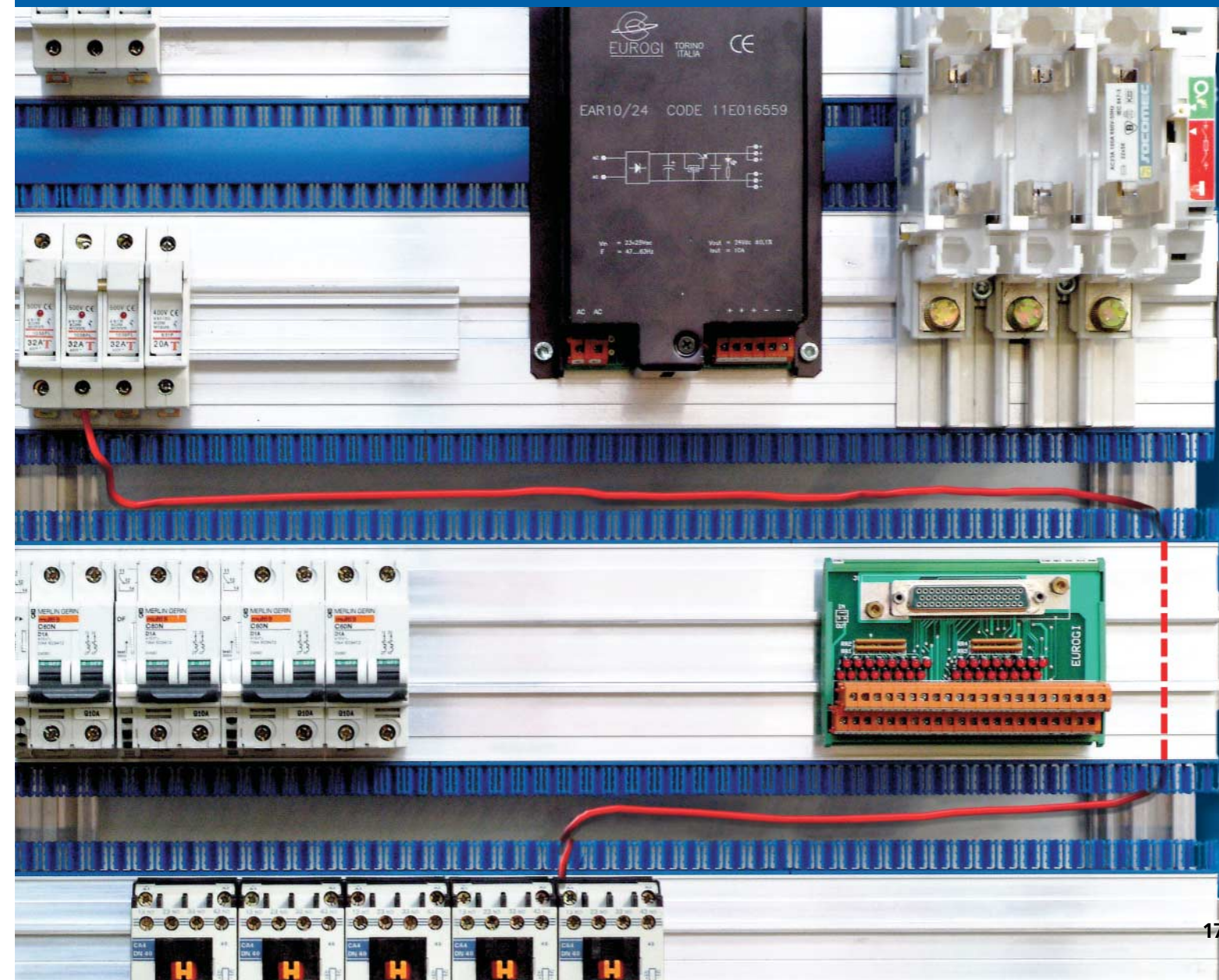



# 5

## The installation is more accessible

Modifications and maintenance are made easy.  
With Proclip®, all of the components clearly stand out, which facilitates access to the various control points.

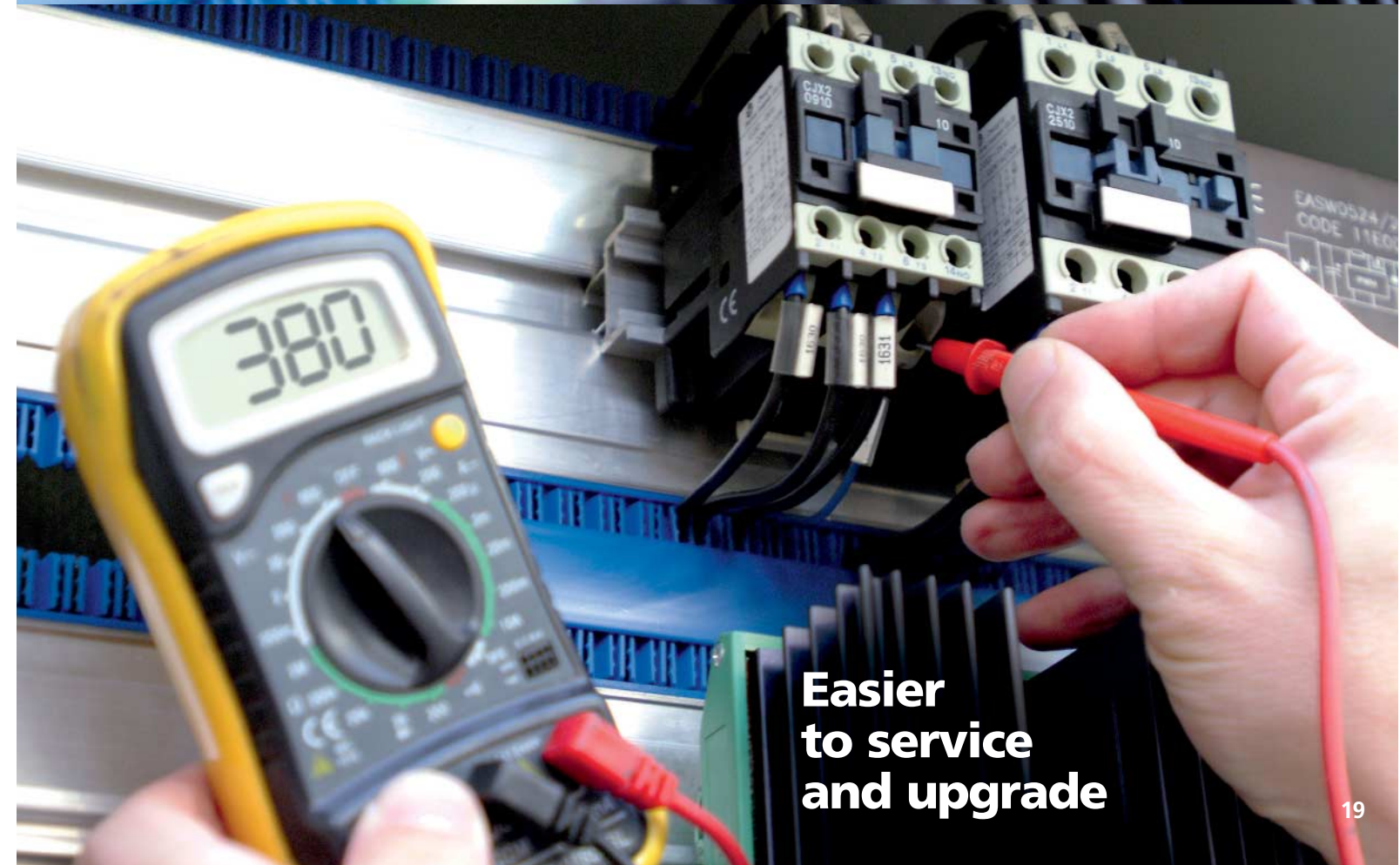



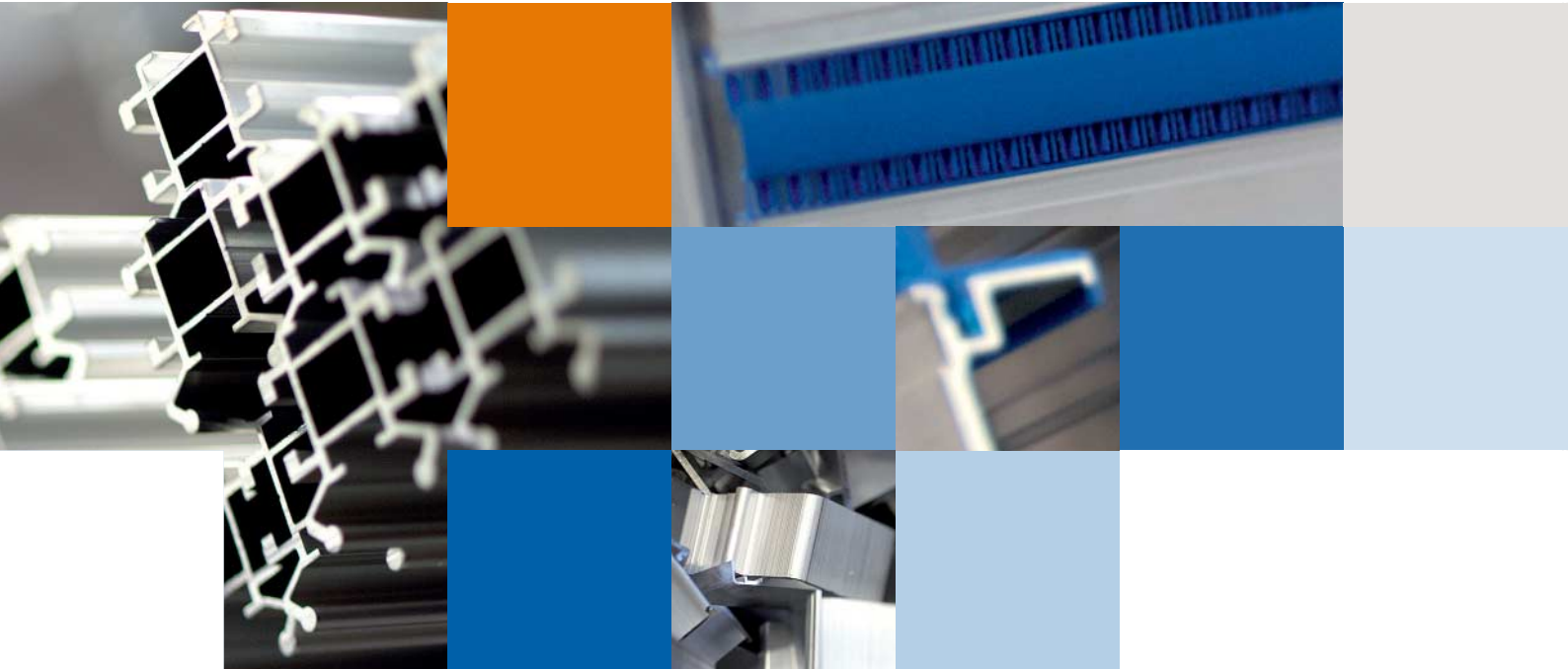

# Components

## Aluminium profiles, Plastic parts Accessories

### Aluminium Profile (*Proclip*®)

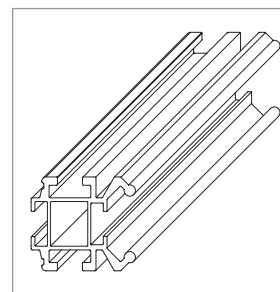

Double sided pillar  
**MDF45**

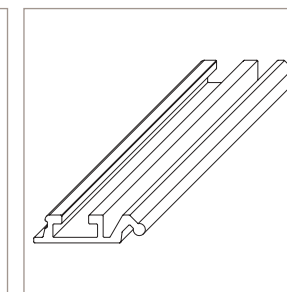

Simple sided pillar  
**MSF12**

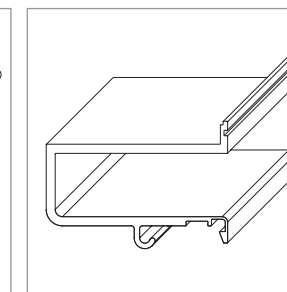

Mounting Bracket  
**EM45**

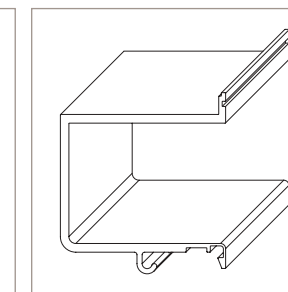

Mounting Bracket  
**EM80**

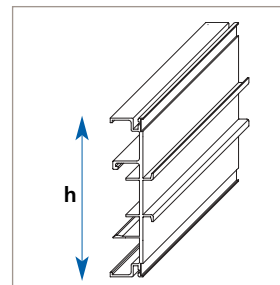

Profile with DIN rail  
**PPA**

PPA	h	Lg mm
PPA	55	/.....
PPA	75	/.....
PPA	95	/.....
PPA	115	/.....
PPA	135	/.....

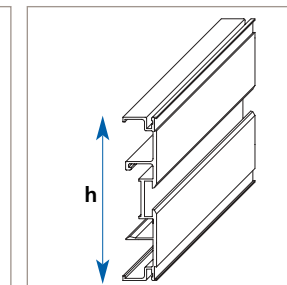

Flat profile  
**PP**

PP	h	Lg mm
PP	55	/.....
PP	75	/.....
PP	95	/.....
PP	115	/.....
PP	135	/.....
PP	155	/.....
PP	170	/.....

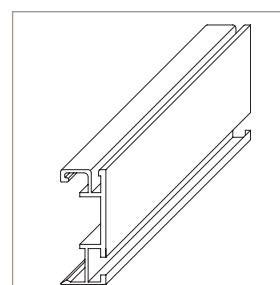

Flat profile bottom mount  
**PPB55**

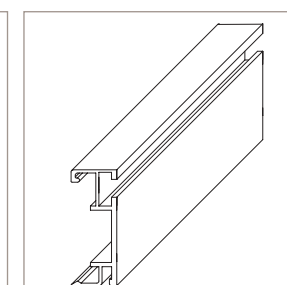

Flat profile top mount  
**PPH55**

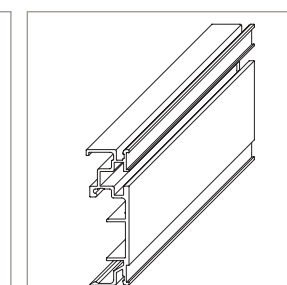

Flat profile top mount  
**PPH75**

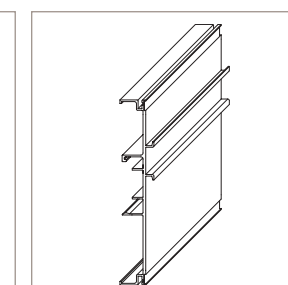

Profile with offset DIN rail  
**PPA170**

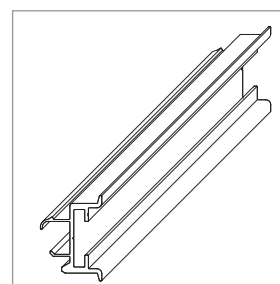

Snap in DIN rail  
**PS35**

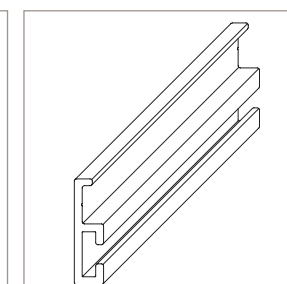

Mounting profile  
**PM50**

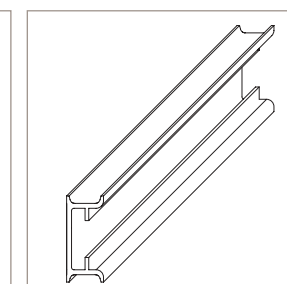

Screw mount Din rail  
**DIN35**

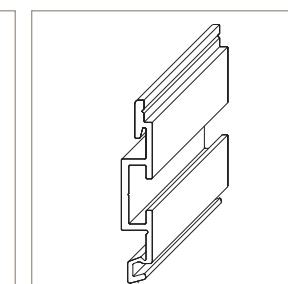

DIN Rail Adaptor  
**SD35**

## Plastic Parts (Proclip®) UL 94 HB - UL 94 VO

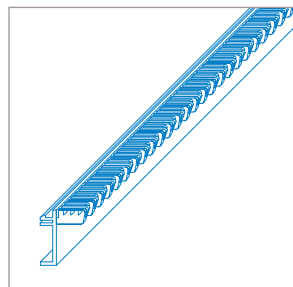

Wire guide comb  
PF350

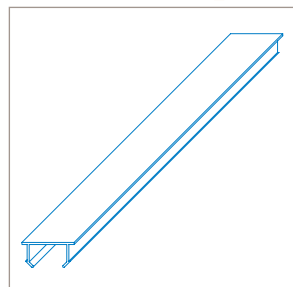

Comb Cover  
CPF20

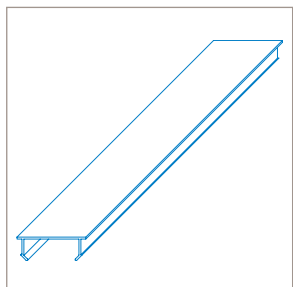

Wide Comb Cover  
CPF30

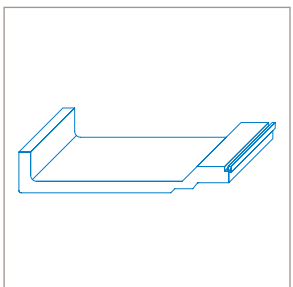

Mounting Bracket Cap  
CP45

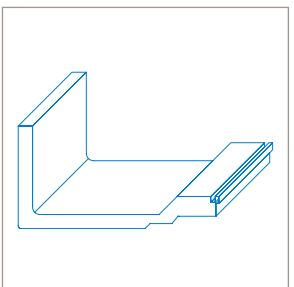

Mounting Bracket Cap  
CP80

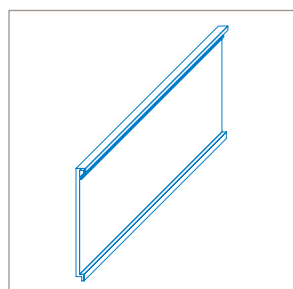

Side cover  
FL80

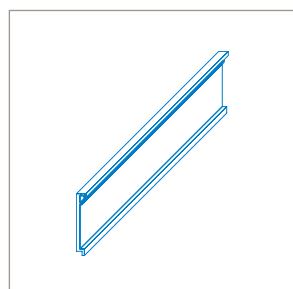

Side cover  
FL45

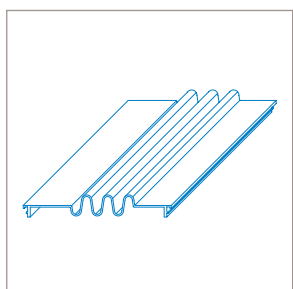

Interframe cover  
CEC100

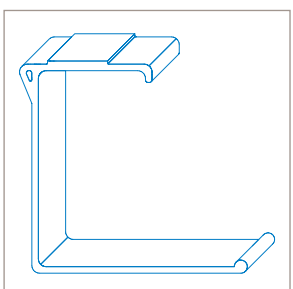

Wiring bracket  
BC80

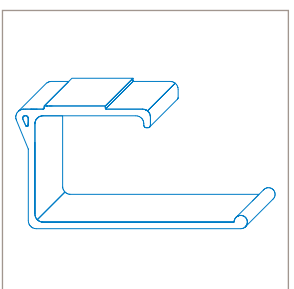

Wiring bracket  
BC45

All plastic parts are available in blue or grey.

## Accessories

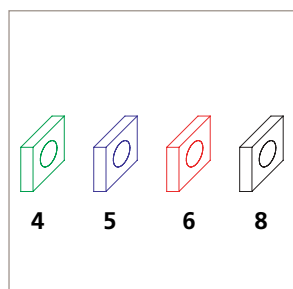

Rectangular nuts  
ERM

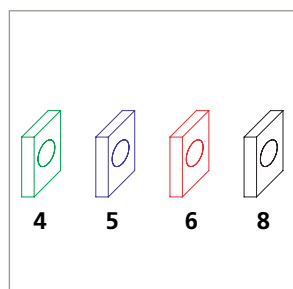

Square Nuts  
ECM

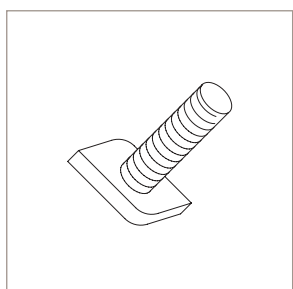

Hammer screw  
VMM8

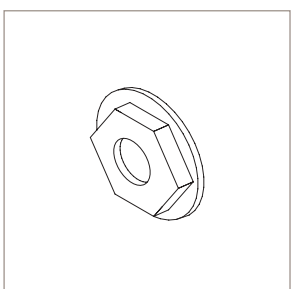

Locking Nut  
EEM8

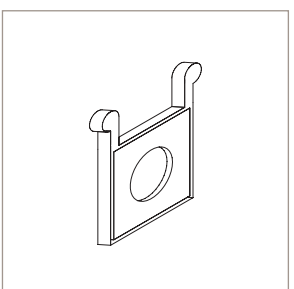

Cage Cover  
ECC

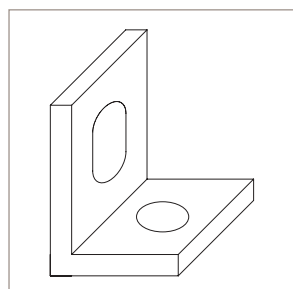

90 degrees fixing bracket  
EDFA

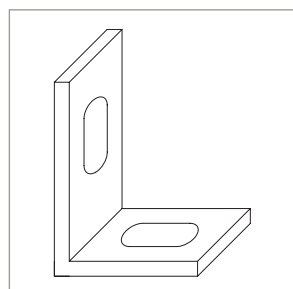

90 degrees fixing bracket  
EDFB

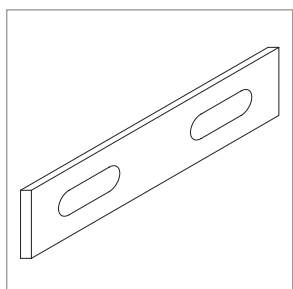

Fixing bracket  
PDF

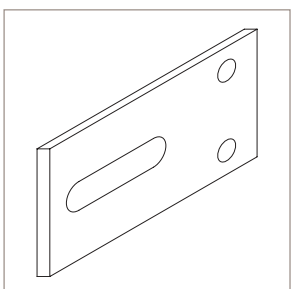

Fixing bracket  
PDFR

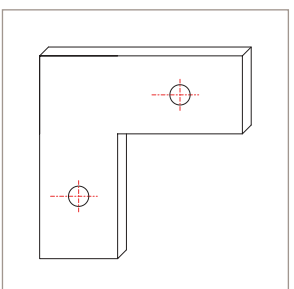

L Fixing bracket  
EP65

## Aluminium Profile (Prolight®)

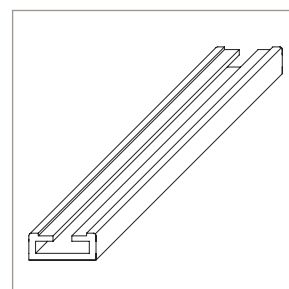

C Light pillar  
MSF10

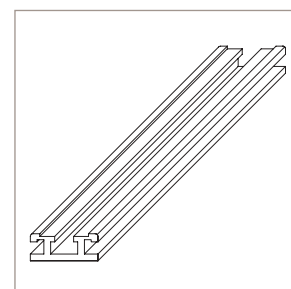

Light pillar  
MSF11

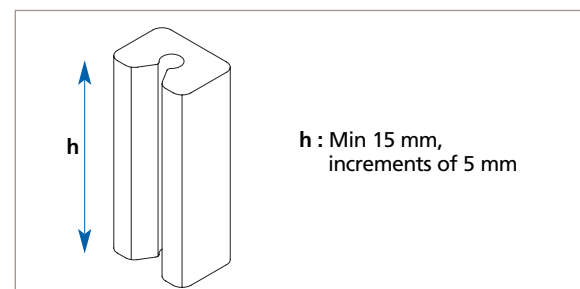

Light mounting bracket  
EM

h : Min 15 mm,  
increments of 5 mm

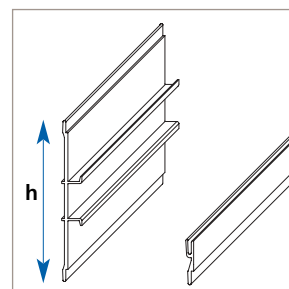

Light profile  
PPE

Light extension  
R20

PPE	h	Lg mm
PPE	55	/.....
PPE	75	/.....
PPE	95	/.....
PPE	115	/.....
R	20	/.....

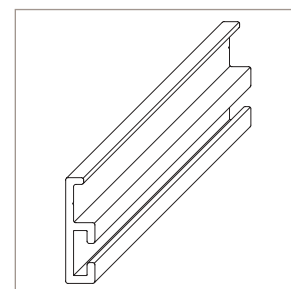

Mounting profile  
PM50

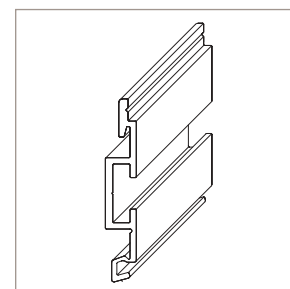

DIN Rail Adaptor  
SD35

## Plastic Parts (Prolight®) UL 94 HB - UL 94 VO

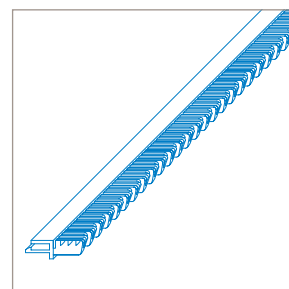

Light guiding comb  
PFE350

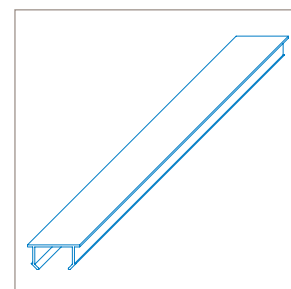

Comb Cover  
CPF20

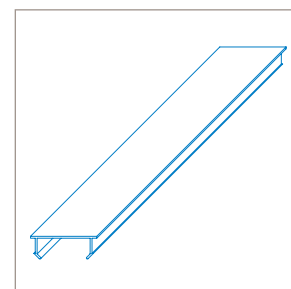

Wide Comb Cover  
CPF30

All plastic parts are  
available in blue or grey.